

HOME  
easy



# HE-413 Remote control Outdoor PIR & Socket

RE-INVENTING THE HOME

V1.0

## Installation:

1. First select your required location, it's recommended that the PIR is installed approximately 3 metres off the ground (ideally under the eaves of the building) and, away from direct sources of sunlight or heat.

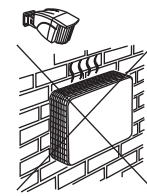
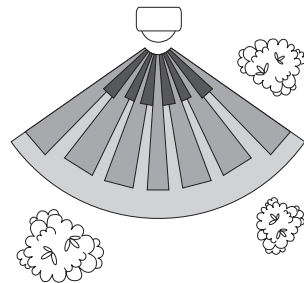
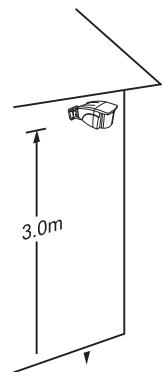
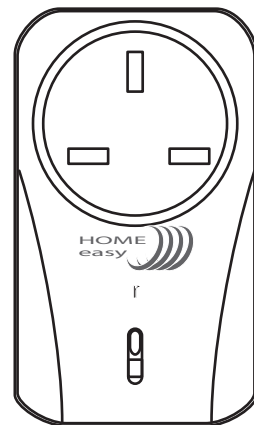
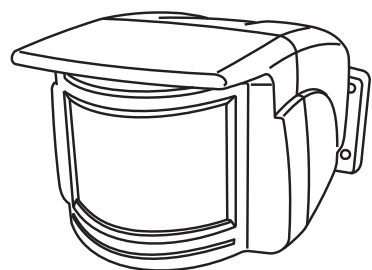

**Avoid Direct Heat Sources**

**Warning:** Avoid installing the Remote Control PIR onto metallic surfaces and above heating vents as this will affect the operating performance.

## Detection Distance

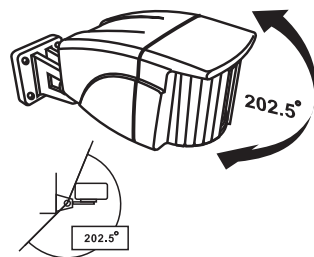
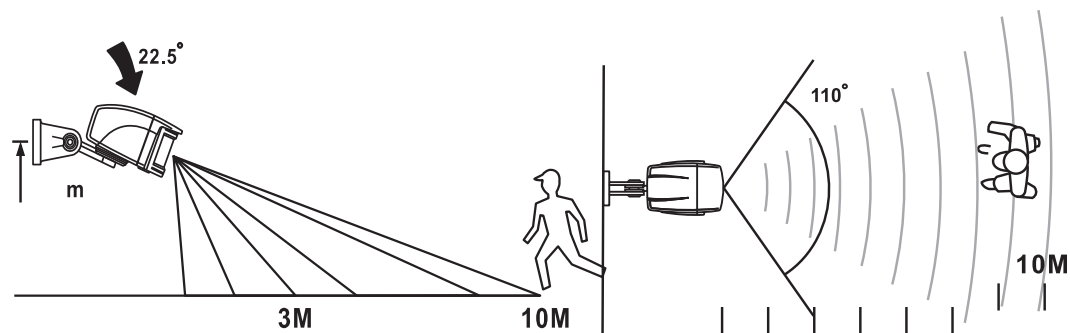

2. Remove the PIR unit from the base and using the mounting bracket as a template mark and drill appropriate holes and fix the bracket securely using the appropriate screws and wall plugs (included).

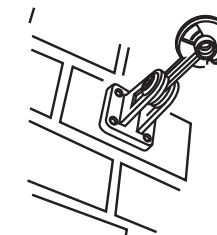
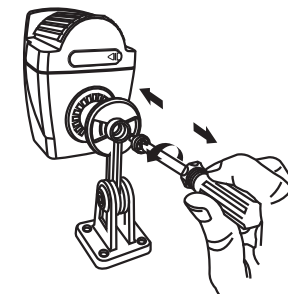

## Changing Batteries:

1. Unclip the battery cover from the bottom of the PIR using a small screw driver.

2. Remove the batteries and replace using 3 new 'AAA' batteries, making sure the polarity is correct.

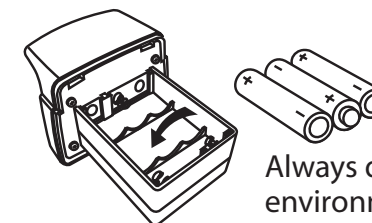
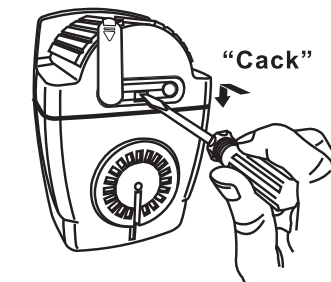

Always dispose of old batteries in an environmentally responsible way

3. Replace the battery cover making sure the rubber seal is correctly aligned and firmly push the case together.

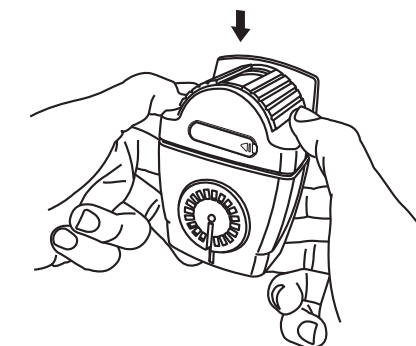
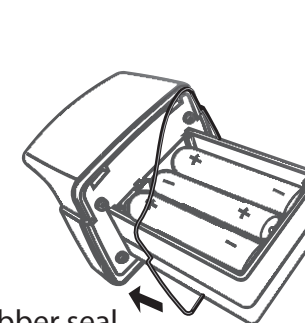

The HE-413 Outdoor PIR Kit adds extra security and ease of use to your Home Easy products

### PIR:

- Selectable timer setting
- 10Metre Detection Range
- IP44 Weather Proof
- 25 Metre Wire Free Range
- Battery Powered 3\*AAA

### Socket:

- 3000W Load Max
- Indoor use only

The HE-413 allows you to control your HomeEasy Receiver sockets or modules via a wire free remote control PIR sensor.

When the PIR beam is broken the outdoor PIR will switch on your Remote control socket for between 15 seconds and 4 Minutes.

Ideal for controlling out door lighting, staircase lighting and house hold lighting for added security.

Compatible with all HomeEasy products.

### Pairing/Deleting with Remote Control:

Up to Six remote control units can be paired with each HomeEasy Receiver socket or module, to pair the outdoor PIR with a receiver unit, remove the battery cover and, slide the switch to DEL.

Now press the "Learn" button, the LED will start to flash, now slide the "LEARN" switch to "SET", the units are now paired together.

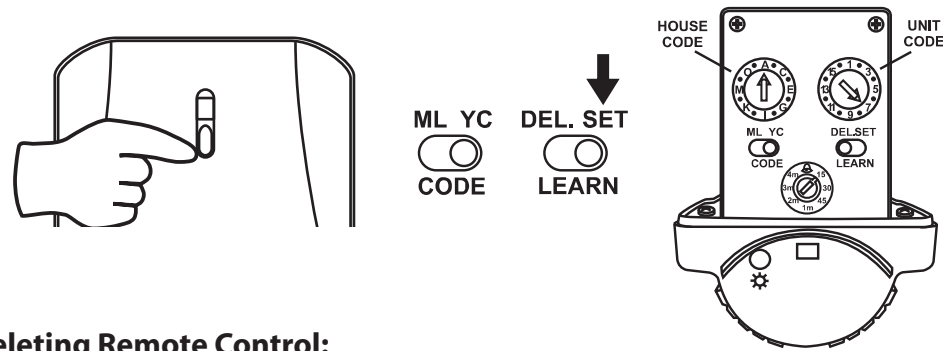

### Deleting Remote Control:

To delete the PIR from the memory of a HomeEasy remote control receiver socket or module, simply press the "Learn" button. The LED will start to blink; slide the "LEARN" switch to "DEL", the LED will blink twice to confirm that the remote control has been removed from the receiver sockets memory.

### Remote Socket reset:

To delete all the remote control units from the memory of the receiver socket, hold the "Learn" button for more than 6 seconds, the LED will start to blink continuously. Press and hold the "Learn" button again, the LED will blink twice to confirm that all paired remote controls have been deleted from the receiver sockets memory.

### Day/Night Setting:

The PIR can operate in 24Hr a day or night mode (Low Level Conditions <10Lux). To select night only mode, remove the cover from the bottom of the PIR and press the "LUX" button as shown below.

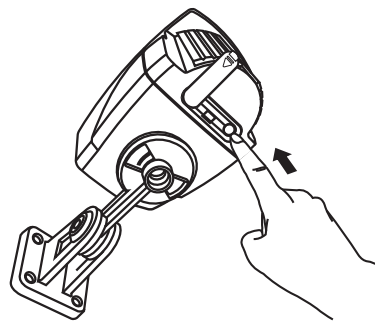

### Setting Timer :

The HomeEasy Outdoor PIR will switch on the receiver socket or module for a predefined period of time when activated, this can be set between 15 seconds and 4 minutes.

Timer Setting:

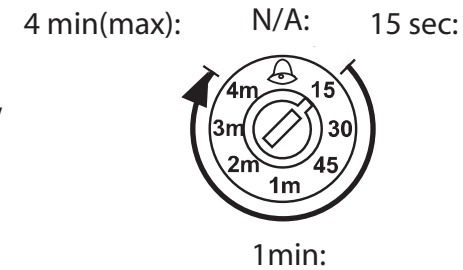

To select the time period, remove the battery cover and using a small screw driver rotate the dial to select the required time.

### Detection Area:

The PIR detection area is 110 degrees, this can be reduced using the clip-on covers (included). if required the covers can be cut to size.

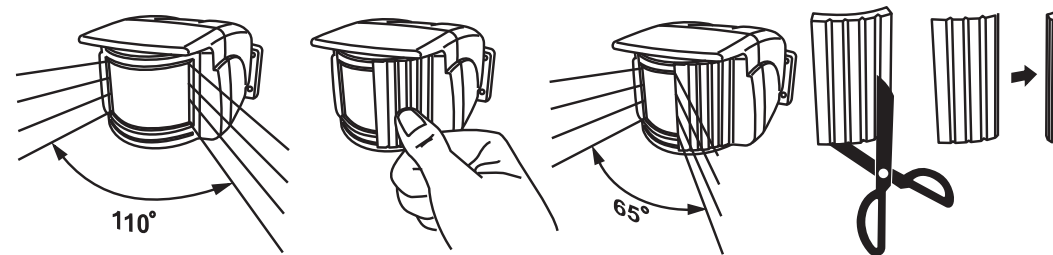

if required the covers can be cut to size.

### Product Specification:

Remote Control: HE-403  
 Battery: 3 \* AAA  
 Range: 25Metres (Open Distance)  
 Frequency: 433.92MHz  
 IP44 Weather Proof

Remote Socket: HE-310  
 Max Load: 3000W (Max)  
 Indoor Use Only

**Warning:** Never Exceed the Product Specification

### Help Section :

- No Activation: -Check the battery life and pairing with receiver socket or module.
- Receiver stays ON continuously: -The PIR might be receiving false signals due to the selected location, try adjusting the angle.
- Radom Activation: -Wind/rain can cause the PIR unit to activate , try a new location if needed.  
 -Small animals can activate the PIR.  
 -Try selecting a new address code.  
 -Passing traffic or pedestrian can activate the PIR, alter the detection angle.

**RF Range:** The radio signals operating distance is reduced when the signal has to pass through walls. The radio signals achieve a range of 25m; this can be reduced depending on the type of material

### Range Reduction Guide:

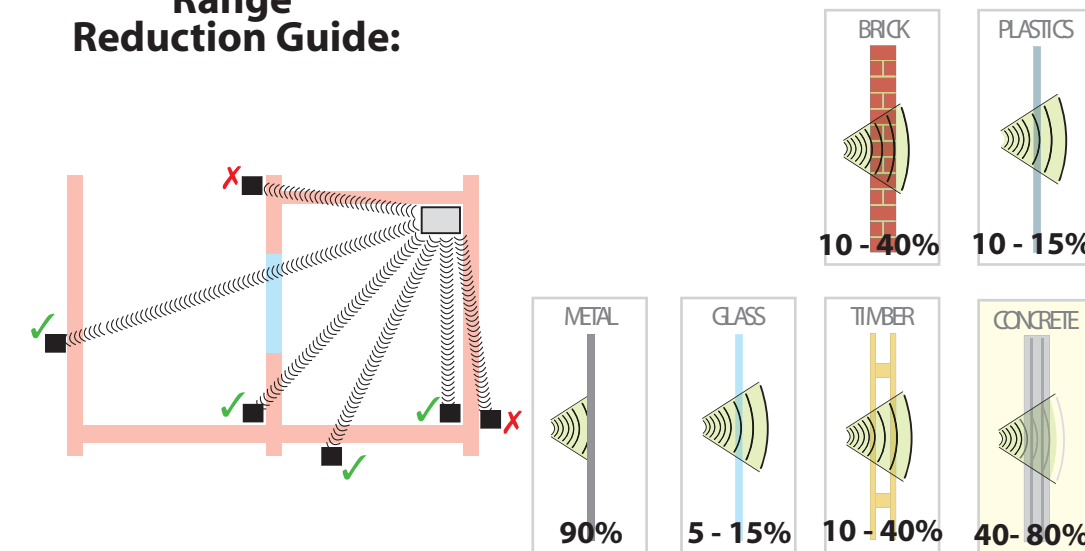

### Contact:

C H Byron  
 34, Sherwood Rd  
 Aston Fields  
 Bromsgrove  
 B60 3DR

### Helpline: 0845 2301 231

Tel: 0845 2301231  
 Fax: 01527 557701  
 Web: [www.chbyron.com](http://www.chbyron.com)  
 E-mail: [support@chbyron.com](mailto:support@chbyron.com)

